



Rubinetterie Fiorentine®

Artigianato di alta qualità dal 1860

SERIE MINIMALE



CATALOGO

7

2026 N°1

- BAGNO Pag. 2 - CUCINA Pag. 16 -

SERIE MINIMA BAGNO

MANOPOLE INTERCAMBIABILI



INCROCIO

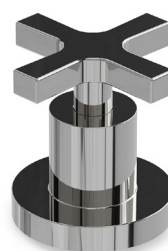

CROCE

MANOPOLE INTERCAMBIABILI



LISCIA



DECORATA

ART. 84

MONOFORO DA LAVABO CON SCARICO
EN - SINGLE-HOLE SINK WITH DRAIN
FR - MONOTROU DE LAVABO AVEC DRAIN
ES - MONOFORO DE LAVABO CON DESCARGA
RU - ОДНОПРОРЕЗНАЯ РАКОВИНА С СЛИВОМ



RIALZO OPZIONALE



mm L: 180 x H: 277 x P: 157

INTERASSE BOCCA EROGAZIONE: 130 mm Ø: 18 mm

ART. 84/B

MONOFORO DA BIDET CON SCARICO
EN - SINGLE-HOLE BIDET WITH EXHAUST
FR - MONOTROU DE BIDET AVEC DRAIN
ES - MONOAGUJERO DE BIDET CON DESCARGA
RU - БИДЕ С ОДНИМ ОТВЕРСТИЕМ И ВЫХЛОПНЫМ ГАЗОМ



mm L: 180 x H: 192 x P: 156
INTERASSE BOCCA EROGAZIONE: 110 mm Ø: 18 mm

ART. 85

MONOFORO DA LAVABO CON SCARICO
EN - SINGLE-HOLE SINK WITH DRAIN
FR - MONOTROU DE LAVABO AVEC DRAIN
ES - MONOFORO DE LAVABO CON DESCARGA
RU - ОДНОПРЕЗНАЯ РАКОВИНА С СЛИВОМ



mm L: 180 x H: 275 x P: 160
INTERASSE BOCCA EROGAZIONE: 130 mm Ø: 18 mm

ART. 85/B

MONOFORO DA BIDET CON SCARICO
EN - SINGLE-HOLE BIDET WITH EXHAUST
FR - MONOTROU DE BIDET AVEC DRAIN
ES - MONOAGUJERO DE BIDET CON DESCARGA
RU - БИДЕ С ОДНИМ ОТВЕРСТИЕМ И ВЫХЛОПНЫМ ГАЗОМ



mm L: 180 x H: 185 x P: 156
INTERASSE BOCCA EROGAZIONE: 110 mm Ø: 18 mm

ART. 116.54

GRUPPO VASCA DA PARETE
EN - WALL TUB ASSEMBLY
FR - GROUPE BAIGNOIRE MURALE
ES - GRUPO BAÑERA DE PARED
RU - СБОРКА СТЕНОВЫХ ВАНН



mm L: 257 x H: 127 x P: 232



ART. 116

GRUPPO VASCA DA PARETE CON DOCCETTA
EN - WALL TUB ASSEMBLY WITH SHOWER
FR - ENSEMBLE BAIGNOIRE MURALE AVEC DOUCHE
ES - GRUPO BAÑERA DE PARED CON DUCHA
RU - НАСТЕННАЯ ВАННА С ДУШЕМ

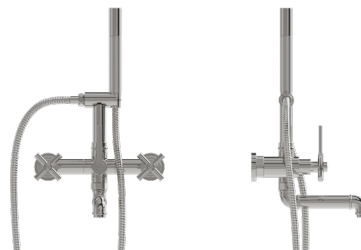

mm L: 257 x H: 422 x P: 232



ART. 116/G

GRUPPO DA BORDOVASCA CON DOCCETTA
EN - POOLSIDE GROUP WITH SHOWER
FR - GROUPE DE BORDOVASCA AVEC DOUCHE
ES - GRUPO DE BORDOVASCA CON DUCHA
RU - ГРУППА У БАССЕЙНА С ДУШЕМ

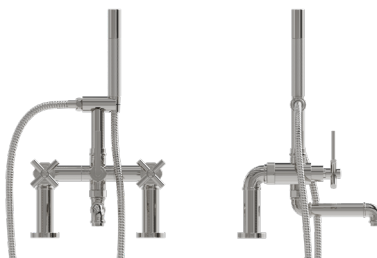

mm L: 257 x H: 433 x P: 280



ART. 116/C

GRUPPO VASCA DA PAVIMENTO CON DOCCETTA
EN - FLOOR TUB ASSEMBLY WITH SHOWER
FR - ENSEMBLE BAIGNOIRE AU SOL AVEC DOUCHE
ES - GRUPO BAÑERA DE SUELO CON DUCHA
RU - НАПОЛЬНАЯ ВАННА С ДУШЕМ



mm L: 257 x H: 1110 x P: 280



ART. 116/P

GRUPPO VASCA DA PAVIMENTO CON DOCCETTA E PORTA ASCIUGAMANI
EN - FLOOR TUB ASSEMBLY WITH SHOWER AND TOWEL HOLDER
FR - ENSEMBLE BAIGNOIRE AU SOL AVEC DOUCHE ET PORTE-SERVIETTES
ES - GRUPO BAÑERA DE SUELO CON DUCHA Y TOALLERO
RU - НАПОЛЬНАЯ ВАННА С ДУШЕМ И ПОЛОТЕНЦЕМ

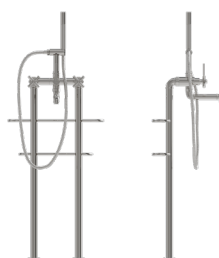

mm L: 435 x H: 1110 x P: 280



ART. 116/S

GRUPPO VASCA/DOCCIA ESTERNO DA PARETTE SENZA DOCCETTA
EN - EXTERNAL PARETTE BATH/SHOWER GROUP WITHOUT SHOWER
FR - ENSEMBLE BAIGNOIRE/DOUCHE EXTÉRIEUR SANS DOUCHETTE
ES - GRUPO BAÑERA/DUCHA EXTERIOR DE PARETTE SIN DUCHA
RU - БАССЕЙН/НАРУЖНАЯ ДУШЕВАЯ ГРУППА ОТ PARETTE БЕЗ ДУША



mm L: 265 x H: 1230 x P: 474



ART. 116/S/DX

GRUPPO VASCA/DOCCIA ESTERNO DA PARETE CON DOCCETTA SCORREVOLE
EN - WALL-MOUNTED OUTDOOR BATH/SHOWER ASSEMBLY WITH SLIDING SHOWER
FR - ENSEMBLE BAIGNOIRE/DOUCHE EXTÉRIEUR MURAL AVEC DOUCHETTE COULISSANTE
ES - GRUPO BAÑERA/DUCHA EXTERIOR DE PARED CON DUCHA CORREDERA
RU - НАСТЕННАЯ ВАННА/ДУШ С РАЗДВИЖНЫМ ДУШЕМ



mm L: 256 x H: 1230 x P: 474



ART. 116/P/S/DX

GRUPPO VASCA/DOCCIA ESTERNO DA PAVIMENTO CON DOCCETTA SCORREVOLE
EN - OUTDOOR FLOOR BATH/SHOWER ASSEMBLY WITH SLIDING SHOWER
FR - ENSEMBLE BAIGNOIRE/DOUCHE EXTÉRIEUR AU SOL AVEC DOUCHETTE COULISSANTE
ES - GRUPO BAÑERA/DUCHA EXTERIOR DE SUELO CON DUCHA CORREDERA
RU - НАПОЛЬНАЯ ВАННА/ДУШ С РАЗДВИЖНЫМ ДУШЕМ

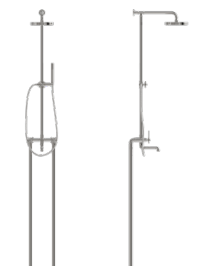

mm L: 256 x H: 2260 x P: 521



ART. 125

BATTERIA PER VASCA DA INCASSO
EN - BUILT-IN TUB BATTERY
FR - BATTERIE POUR BAIGNOIRE ENCASTRÉE
ES - BATERÍA PARA BAÑERA EMPOTRADA
RU - ВСТРОЕННАЯ БАТАРЕЯ ВАННЫ



mm H: 239 x P: 199

ART. 126

BATTERIA DA BORDOVASCA 5 FORI CON DOCCETTA ESTRAIBILE
EN - 5-HOLE TROUGH BATTERY WITH REMOVABLE SHOWER
FR - BATTERIE BORDOVASCA 5 TROUS AVEC DOUCHETTE AMOVIBLE
ES - BATERÍA BORDOVASCA 5 AGUJEROS CON DUCHA EXTRAÍBLE
RU - 5-ДЫРОЧНЫЙ АККУМУЛЯТОР С СЪЕМНЫМ ДУШЕМ



mm H: 250 x P: 204

INTERASSE BOCCA EROGAZIONE: 165 mm Ø: 20 mm

ART. 140/1

RUBINETTO D'ARRESTO DA INCASSO
EN - RECESSED STOP FAUCET
FR - ROBINET D'ARRÊT ENCASTRÉ
ES - GRIFO DE RETENCIÓN EMPOTRADO
RU - ВСТРОЕННЫЙ СТОП-КРАН



mm D: 67,4 x H: 72,7

ART. 140/2

RUBINETTO D'ARRESTO DA INCASSO
EN - RECESSED STOP FAUCET
FR - ROBINET D'ARRÊT ENCASTRÉ
ES - GRIFO DE RETENCIÓN EMPOTRADO
RU - ВСТРОЕННЫЙ СТОП-КРАН

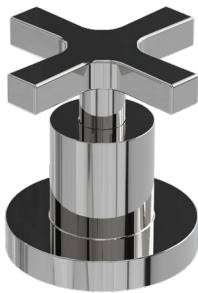

mm D: 63 x H: 62,6

ART. 142

BATTERIA DA LAVABO 3 FORI CON SCARICO
EN - 3-HOLE WASHBASIN BATTERY WITH DRAIN
FR - BATTERIE DE LAVABO 3 TROUS AVEC ÉVACUATION
ES - BATERÍA DE LAVABO 3 ORIFICIOS CON DESCARGA
RU - БАТАРЕЯ С 3-ДЫРКОЙ ДЛЯ УМЫВАЛЬНИКА С ДРЕНАЖЕМ



mm L: 342 x H: 210 x P: 160

INTERASSE BOCCA EROGAZIONE: 165 mm Ø: 20 mm

ART. 142/P

BATTERIA DA LAVABO 3 FORI DA PARETE CON SCARICO
EN - SINK BATTERY 3 WALL HOLES WITH DRAIN
FR - BATTERIE DE LAVABO 3 TROUS DE MUR AVEC DRAIN
ES - BATERÍA DE LAVABO 3 AGUJEROS DE PARED CON DESCARGA
RU - ЕМКАЯ БАТАРЕЯ 3 НАСТЕННЫЕ ОТВЕРСТИЯ С СЛИВОМ



mm L: 343 x H: 82,2 x P: 212

INTERASSE BOCCA EROGAZIONE: 200 mm Ø: 20 mm

ART. 142/PL

BATTERIA DA LAVABO 3 FORI DA PARETE SU PLACCA SAGOMATA CON SCARICO
EN - SINK BATTERY 3 WALL HOLES ON SHAPED PLATE WITH DRAIN
FR - BATTERIE DE LAVABO 3 TROUS MURAUX SUR PLAQUE PROFILÉE AVEC DRAIN
ES - BATERÍA DE LAVABO 3 ORIFICIOS DE PARED EN PLACA MOLDEADA CON DESCARGA
RU - РАКОВИНА БАТАРЕЯ 3 НАСТЕННЫЕ ОТВЕРСТИЯ НА ОБРАЗОВАННОЙ ПЛАСТИНЕ С СЛИВОМ



mm L: 280 x H: 97,3 x P: 214

INTERASSE BOCCA EROGAZIONE: 200 mm Ø: 20 mm

ART. 146

BATTERIA DA BIDEI 3 FORI CON SCARICO
EN - 3-HOLE BIDET BATTERY WITH DRAIN
FR - BATTERIE DE BIDEI 3 TROUS AVEC DRAIN
ES - BATERÍA DE BIDEI 3 AGUJEROS CON DESCARGA
RU - 3-ОТВЕРСТИЕ БИДЕ БАТАРЕЯ С СЛИВОМ



mm L: 343 x H: 115 x P: 156

INTERASSE BOCCA EROGAZIONE: 110 mm Ø: 18 mm

ART. 154/DX

GRUPPO DOCCIA ESTERNO DA PARETE CON DOCCETTA E GANCIO DUPLEX
EN - EXTERNAL WALL SHOWER ASSEMBLY WITH SHOWER HEAD AND DUPLEX HOOK
FR - ENSEMBLE DE DOUCHE MURAL EXTÉRIEUR AVEC DOUCHE ET CROCHET DUPLEX
ES - DUCHA EXTERIOR DE PARED CON DUCHA Y GANCHO DÚPLEX
RU - ВНЕШНИЙ НАСТЕННЫЙ ДУШ С ДУШЕВОЙ ГОЛОВКОЙ И ДУПЛЕКСНЫМ КРЮЧКОМ



mm H: 240 x P: 150



ART. 154/S

GRUPPO DOCCIA ESTERNO DA PARETE SENZA DOCCETTA
EN - EXTERNAL WALL SHOWER ASSEMBLY WITHOUT SHOWER
FR - ENSEMBLE DE DOUCHE MURAL SANS DOUCHETTE
ES - DUCHA DE PARED EXTERIOR SIN DUCHA
RU - ВНЕШНЯЯ СТЕНОВАЯ ДУШЕВАЯ УСТАНОВКА БЕЗ ДУША



mm L: 256 x H: 1150 x P: 474



ART. 154/P/S

GRUPPO DOCCIA ESTERNO DA PAVIMENTO SENZA DOCCETTA
EN - OUTDOOR FLOOR SHOWER ASSEMBLY WITHOUT SHOWER
FR - ENSEMBLE DE DOUCHE EXTÉRIEURE SANS DOUCHETTE
ES - GRUPO DE DUCHA EXTERIOR DE SUELO SIN DUCHA
RU - НАПОЛЬНАЯ ДУШЕВАЯ УСТАНОВКА НА ПОЛУ БЕЗ ДУША



mm L: 228 x H: 2270 x P: 508



ART. 154/S/DX

GRUPPO DOCCIA ESTERNO DA PARETE CON DOCCETTA SCORREVOLE
EN - EXTERNAL WALL SHOWER ASSEMBLY WITH SLIDING SHOWER
FR - ENSEMBLE DE DOUCHE MURAL EXTÉRIEUR AVEC DOUCHETTE COULISSANTE
ES - DUCHA EXTERIOR DE PARED CON DUCHA CORREDERA
RU - ВНЕШНЯЯ НАСТЕННАЯ ДУШЕВАЯ УСТАНОВКА С РАЗДВИЖНЫМ ДУШЕМ



mm L: 256 x H: 1150 x P: 474



ART. 154/P/S/DX

GRUPPO DOCCIA ESTERNO DA PAVIMENTO CON DOCCETTA SCORREVOLE
EN - OUTDOOR FLOOR SHOWER ASSEMBLY WITH SLIDING SHOWER
FR - ENSEMBLE DOUCHE EXTÉRIEURE AU SOL AVEC DOUCHETTE COULISSANTE
ES - GRUPO DE DUCHA EXTERIOR DE SUELO CON DUCHA DESLIZANTE
RU - НАПОЛЬНАЯ ДУШЕВАЯ УСТАНОВКА С РАЗДВИЖНЫМ ДУШЕМ



mm L: 256 x H: 2260 x P: 521



ART. 185

ASTA DOCCIA CON DOCCETTA SCORREVOLE E PRESA ACQUA
EN - SHOWER ROD WITH SLIDING SHOWER AND WATER SOCKET
FR - BARRE DE DOUCHE AVEC DOUCHETTE COULISSANTE ET PRISE D'EAU
ES - BARRA DE DUCHA CON DUCHA DESLIZANTE Y TOMA DE AGUA
RU - ДУШЕВАЯ СТЕРЖЕНЬ С РАЗДВИЖНЫМ ДУШЕМ И ВОДЯНОЙ РОЗЕТКОЙ



ART. 2062

MISCELATORE PER DOCCIA DA INCASSO CON PULSANTE DI DEVIAZIONE (CARTUCCIA DIAMETRO 40mm)
EN - RECESSED SHOWER MIXER WITH DETOUR BUTTON (40mm DIAMETER CARTRIDGE)
FR - MITIGEUR DE DOUCHE ENCASTRÉ AVEC BOUTON DE DÉVIATION (CARTOUCHE DIAMÈTRE 40mm)
ES - MEZCLADOR PARA DUCHA EMPOTRABLE CON BOTÓN DE DESVIACIÓN (CARTUCHO DIÁMETRO 40mm)
RU - ВСТРОЕННАЯ ДУШЕВАЯ СМЕСИТЕЛЬ С КНОПКОЙ ОБХОДА (40мм ДИАМЕТР КАРТРИДЖА)



mm L: 140 x H: 202 x P: 55,8

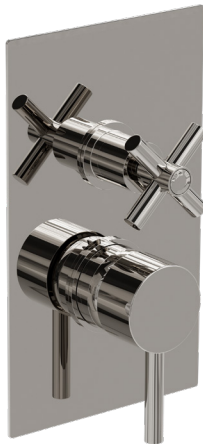

ART. 2063

MISCELATORE PER DOCCIA DA INCASSO A 3 VIE CON MANIGLIA DI DEVIAZIONE, A RICHIESTA 2 VIE (CARTUCCIA DIAMETRO 40mm)
EN - 3-WAY BUILT-IN SHOWER MIXER WITH DIVERSION HANDLE, 2-WAY ON REQUEST (40mm DIAMETER CARTRIDGE)
FR - MÉLANGEUR POUR DOUCHE ENCASTRÉ À 3 VOIES AVEC POIGNÉE DE DÉVIATION, SUR DEMANDE 2 VOIES (CARTOUCHE DIAMÈTRE 40mm)
ES - MEZCLADOR PARA DUCHA EMPOTRADO DE 3 VÍAS CON MANIJA DE DESVÍO, A PETICIÓN 2 VÍAS (CARTUCHO DIÁMETRO 40mm)
RU - ВСТРОЕННЫЙ 3-ТАКТНЫЙ МИКСЕР ДЛЯ ДУША С ПЕРЕНАПРАВЛЯЮЩЕЙ РУЧКОЙ, 2-ТАКТНЫЙ ПО ЗАПРОСУ (КАРТРИДЖ ДИАМЕТРОМ 40 ММ)

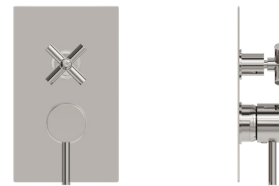

mm L: 140 x H: 240 x P: 68.1



ART. 2070

MISCELATORE PER DOCCIA DA INCASSO (CARTUCCIA DIAMETRO 40 mm)
EN - BUILT-IN SHOWER MIXER (40mm DIAMETER CARTRIDGE)
FR - MITIGEUR DE DOUCHE ENCASTRABLE (CARTOUCHE DIAMÈTRE 40mm)
ES - MEZCLADOR DE DUCHA EMPOTRADO (CARTUCHO DIÁMETRO 40mm)
RU - ВСТРОЕННАЯ ДУШЕВАЯ СМЕСИТЕЛЬ (40мм ДИАМЕТР КАРТРИДЖ)

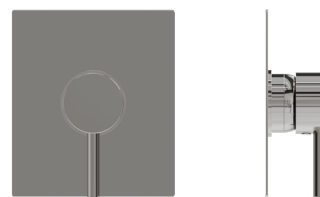

mm L: 140 x H: 161 x P: 55,8

ART. 2142



BATTERIA DA LAVABO CON MISCELATORE E SCARICO
EN - WASHBASIN BATTERY WITH MIXER AND DRAIN
FR - BATTERIE DE LAVABO AVEC MÉLANGEUR ET DÉCHARGE
ES - BATERÍA DE LAVABO CON MEZCLADOR Y DESCARGA
RU - БАТАРЕЯ ДЛЯ УМЫВАЛЬНИКА С МИКСЕРОМ И ДРЕНАЖЕМ



mm L: 145 x H: 245 x P: 162

INTERASSE BOCCA EROGAZIONE: 165 mm Ø: 20 mm

ART. 2142/P



MISCELATORE PER LAVABO A PARETE CON LEVA (CARTUCCIA DIAMETRO 40 mm)
EN - WALL-MOUNTED SINK MIXER WITH LEVER (40 mm DIAMETER CARTRIDGE)
FR - MÉLANGEUR POUR LAVABO MURAL AVEC LEVIER (CARTOUCHE DIAMÈTRE 40 mm)
ES - MEZCLADOR PARA LAVABO DE PARED CON PALANCA (CARTUCHO DIÁMETRO 40 mm)
RU - НАСТЕННЫЙ МИКСЕР ДЛЯ РАКОВИНЫ С РЫЧАГОМ (КАРТРИДЖ ДИАМЕТРОМ 40 мм)



mm L: 175 x H: 110 x P: 212

INTERASSE BOCCA EROGAZIONE: 200 mm Ø: 20 mm

ART. 2142/PL



BATTERIA DA LAVABO CON MISCELATORE E SCARICO DA INCASSO SU PLACCA
EN - WASHBASIN BATTERY WITH MIXER AND RECESSED DISCHARGE ON PLATE
FR - BATTERIE DE LAVABO AVEC MÉLANGEUR ET DÉCHARGE ENCASTRÉE SUR PLAQUE
ES - BATERÍA DE LAVABO CON MEZCLADOR Y DESCARGA INCRUSTADA EN PLACA
RU - БАТАРЕЯ ДЛЯ УМЫВАЛЬНИКА С МИКСЕРОМ И ВЛОЖЕННОЙ РАЗРЯДКОЙ НА ПЛАСТИНЕ



mm L: 270 x H: 146 x P: 214

ART. 2154/DX



GRUPPO DOCCIA ESTERNO DA PARETE CON DOCCETTA E GANCIO DUPLEX (CARTUCCIA DIAMETRO 40 mm)
EN - EXTERNAL WALL SHOWER ASSEMBLY WITH SHOWER AND DUPLEX HOOK (CARTRIDGE DIAMETER 40 mm)
FR - GROUPE DE DOUCHE EXTÉRIEURE À MUR AVEC DOUCHETTE ET CROCHET DUPLEX
(CARTOUCHE DIAMÈTRE 40 mm)
ES - GRUPO DUCHA EXTERIOR DE PARED CON DUCHA Y GANCHO DUPLEX (CARTUCHO DIÁMETRO 40 mm)
RU - ВНЕШНЯЯ СТЕНА ДУШЕВАЯ УСТАНОВКА С ДУШЕМ И ДУПЛЕКСНЫМ КРЮКОМ (ДИАМЕТР КАРТРИДЖА 40 мм)



mm H: 265 x P: 140



ART. 2154/S

GRUPPO DOCCIA ESTERNO DA PARETE SENZA DOCCETTA (CARTUCCIA DIAMETRO 40 mm)
EN - EXTERNAL WALL SHOWER ASSEMBLY WITHOUT SHOWER (CARTRIDGE DIAMETER 40 mm)
FR - GROUPE DE DOUCHE EXTÉRIEURE AVEC MUR SANS DOUCHE (CARTOUCHE DIAMÈTRE 40 mm)
ES - GRUPO DE DUCHA EXTERIOR CON PARED SIN DUCHA (CARTUCHO DIÁMETRO 40 mm)
RU - ВНЕШНЯЯ СТЕНА ДЛЯ ДУША БЕЗ ДУША (КАРТРИДЖ ДИАМЕТР 40 мм)



mm L: 254 x H: 1220 x P: 455



ART. 2154/P/S

GRUPPO DOCCIA ESTERNO DA PAVIMENTO (CARTUCCIA DIAMETRO 40 mm)
EN - OUTDOOR FLOOR SHOWER ASSEMBLY (CARTRIDGE DIAMETER 40 mm)
FR - GROUPE DE DOUCHE EXTÉRIEURE PAR SOL (CARTOUCHE DIAMÈTRE 40 mm)
ES - GRUPO DUCHA EXTERIOR DE SUELO (CARTUCHO DIÁMETRO 40 mm)
RU - УСТАНОВКА ДЛЯ ДУША НА ПОЛУ (ДИАМЕТР КАРТРИДЖА 40 мм)

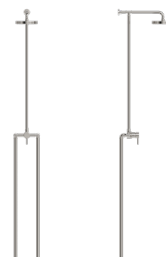

mm L: 230 x H: 2270 x P: 473



ART. 2154/S/DX

GRUPPO DOCCIA ESTERNO DA PARETE CON DOCCETTA SCORREVOLE (CARTUCCIA DIAMETRO 40 mm)
EN - EXTERNAL WALL SHOWER ASSEMBLY WITH SLIDING SHOWER (40 mm DIAMETER CARTRIDGE)
FR - GROUPE DE DOUCHE EXTÉRIEURE À MUR AVEC DOUCHETTE COULISSANTE (CARTOUCHE DIAMÈTRE 40 mm)
ES - GRUPO DUCHA EXTERIOR DE PARED CON DUCHA DESLIZANTE (CARTUCHO DIÁMETRO 40 mm)
RU - ВНЕШНЯЯ СТЕНА ДУШЕВАЯ УСТАНОВКА С РАЗДВИЖНЫМ ДУШЕМ (КАРТРИДЖ ДИАМЕТРОМ 40 мм)



mm L: 254 x H: 1220 x P: 455



ART. 2154/P/S/DX

GRUPPO DOCCIA ESTERNO DA PAVIMENTO CON DOCCETTA SCORREVOLE (CARTUCCIA DIAMETRO 40 mm)
EN - OUTDOOR FLOOR SHOWER ASSEMBLY WITH SLIDING SHOWER (40 mm DIAMETER CARTRIDGE)
FR - GROUPE DE DOUCHE EXTÉRIEURE PAR SOL AVEC DOUCHETTE COULISSANTE (CARTOUCHE DIAMÈTRE 40 mm)
ES - GRUPO DE DUCHA EXTERIOR POR SUELO CON DUCHA DESLIZANTE (CARTUCHO DIÁMETRO 40 mm)
RU - СБОРКА ДЛЯ ДУША НА ПОЛУ НАРУЖНОГО ПОЛА С РАЗДВИЖНЫМ ДУШЕМ (КАРТРИДЖ ДИАМЕТРОМ 40 мм)



mm L: 255 x H: 2270 x P: 500



ART. 3062

MISCELATORE PER DOCCIA DA INCASSO CON PULSANTE DI DEVIAZIONE (CARTUCCIA DIAMETRO 35mm)
 EN - RECESSED SHOWER MIXER WITH DETOUR BUTTON (35mm DIAMETER CARTRIDGE)
 FR - MITIGEUR DE DOUCHE ENCASTRÉ AVEC BOUTON DE DÉVIATION (CARTOUCHE DIAMÈTRE 35mm)
 ES - MEZCLADOR PARA DUCHA EMPOTRABLE CON BOTÓN DE DESVIACIÓN (CARTUCHO DIÁMETRO 35mm)
 RU - ВСТРОЕННАЯ ДУШЕВАЯ СМЕСИТЕЛЬ С КНОПКОЙ ОБХОДА (35мм ДИАМЕТР КАРТРИДЖА)



mm L: 140 x H: 202 x P: 51

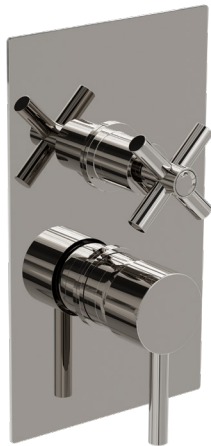

ART. 3063

MISCELATORE PER DOCCIA DA INCASSO A 3 VIE CON MANIGLIA DI DEVIAZIONE, A RICHIESTA 2 VIE (CARTUCCIA DIAMETRO 35mm)
 EN - 3-WAY BUILT-IN SHOWER MIXER WITH DIVERSION HANDLE, 2-WAY ON REQUEST (35mm DIAMETER CARTRIDGE)
 FR - MÉLANGEUR POUR DOUCHE ENCASTRÉ À 3 VOIES AVEC POIGNÉE DE DÉVIATION, SUR DEMANDE 2 VOIES (CARTOUCHE DIAMÈTRE 35mm)
 ES - MEZCLADOR PARA DUCHA EMPOTRADO DE 3 VÍAS CON MANIJA DE DESVÍO, A PETICIÓN 2 VÍAS (CARTUCHO DIÁMETRO 35mm)
 RU - ВСТРОЕННЫЙ 3-ТАКТНЫЙ МИКСЕР ДЛЯ ДУША С ПЕРЕНАПРАВЛЯЮЩЕЙ РУЧКОЙ, 2-ТАКТНЫЙ ПО ЗАПРОСУ (КАРТРИДЖ 35 ММ ДИАМЕТРА)



mm L: 140 x H: 236 x P: 68.1



ART. 3064

MISCELATORE DA LAVABO CON SCARICO (CARTUCCIA DIAMETRO 35mm)
 EN - WASHBASIN MIXER WITH DRAIN (35mm DIAMETER CARTRIDGE)
 FR - MITIGEUR DE LAVABO AVEC VIDANGE (CARTOUCHE DIAMÈTRE 35mm)
 ES - MEZCLADOR DE LAVABO CON DESCARGA (CARTUCHO DIÁMETRO 35mm)
 RU - УМЫВАЛЬНИК С СЛИВНЫМ (35мм ДИАМЕТР КАРТРИДЖ)



mm L: 50 x H: 155 x P: 163



ART. 3066

MISCELATORE DA BIDET CON SCARICO (CARTUCCIA DIAMETRO 35mm)
 EN - BIDET MIXER WITH DRAIN (35mm DIAMETER CARTRIDGE)
 FR - MÉLANGEUR DE BIDET AVEC VIDANGE (CARTOUCHE DIAMÈTRE 35mm)
 ES - MEZCLADOR DE BIDET CON DESCARGA (CARTUCHO DIÁMETRO 35mm)
 RU - БИДЕТ С ДРЕНАЖЕМ (35-миллиметровый ПАТРОН)



mm L: 50 x H: 155 x P: 160

ART. 3070



MISCELATORE PER DOCCIA DA INCASSO (CARTUCCIA DIAMETRO 35 mm)
EN - BUILT-IN SHOWER MIXER (35 mm DIAMETER CARTRIDGE)
FR - MITIGEUR DE DOUCHE ENCASTRABLE (CARTOUCHE DIAMÈTRE 35 mm)
ES - MEZCLADOR DE DUCHA EMPOTRADO (CARTUCHO DIÁMETRO 35 mm)
RU - ВСТРОЕННАЯ ДУШЕВАЯ СМЕСИТЕЛЬ (35 мм ДИАМЕТР КАРТРИДЖ)

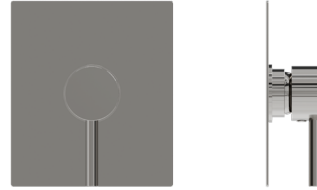

mm L: 116 x H: 158 x P: 61,6

ART. 3071



MISCELATORE DA INCASSO PER LAVABO/LAVELLO (CARTUCCIA DIAMETRO 35 mm)
EN - BUILT-IN MIXER FOR SINK/SINK (35 mm DIAMETER CARTRIDGE)
FR - MÉLANGEUR ENCASTRÉ POUR LAVABO/ÉVIER (CARTOUCHE DIAMÈTRE 35 mm)
ES - MEZCLADOR DE EMBUTO PARA LAVABO/FREGADERO (CARTUCHO DIÁMETRO 35 mm)
RU - ВСТРОЕННЫЙ МИКСЕР ДЛЯ РАКОВИНЫ/РАКОВИНЫ (КАРТРИДЖ ДИАМЕТРОМ 35 мм)



mm L: 80 x H: 120 x P: 58,3

ART. 3085 ART. 3087



RIALZO OPZIONALE

MONOFORO DA LAVABO CON SCARICO (CARTUCCIA DIAMETRO 35mm)
EN - SINGLE-HOLE SINK WITH DRAIN
FR - MONOTROU DE LAVABO AVEC DRAIN
ES - MONOFORO DE LAVABO CON DESCARGA
RU - ОДНОПРОРЕЗНАЯ РАКОВИНА С СЛИВОМ



mm L: 105 x H: 275 x P: 160

INTERASSE BOCCA EROGAZIONE: 130 mm Ø: 18 mm

ART. 3085/B ART. 3088



MONOFORO DA BIDET CON SCARICO (CARTUCCIA DIAMETRO 35mm)
EN - SINGLE-HOLE BIDET WITH EXHAUST
FR - MONOTROU DE BIDET AVEC DRAIN
ES - MONOAGUJERO DE BIDET CON DESCARGA
RU - БИДЕ С ОДНИМ ОТВЕРСТИЕМ И ВЫХЛОПНЫМ ГАЗОМ



mm L: 105 x H: 185 x P: 156

INTERASSE BOCCA EROGAZIONE: 110 mm Ø: 18 mm

ART. 3125/DX

BATTERIA CON MISCELATORE E DEVIATORE (CON SOFFIONE DOCCIA O BOCCA EROGAZIONE)
EN - BATTERY WITH MIXER AND DIVERTER (WITH SHOWER HEAD OR DISPENSING MOUTH)
FR - BATTERIE AVEC MÉLANGEUR ET DÉVIEUR (AVEC CHALUMEAU OU BOUCHE DE DISTRIBUTION)
ES - BATERÍA CON MEZCLADOR Y DESVIADOR (CON DUCHA O BOCA DE DISPENSACIÓN)
RU - БАТАРЕЯ С МИКСЕРОМ И РАЗВОДИТЕЛЕМ (С ДУШЕВОЙ ГОЛОВКОЙ ИЛИ РАЗДАТОЧНЫМ ОТВЕРСТИЕМ)



mm L: 300 x H: 263 x P: 86.4

ART. 3125/DX/PL

BATTERIA CON MISCELATORE E DEVIATORE SU PLACCA (CON SOFFIONE DOCCIA O BOCCA EROGAZIONE)
EN - BATTERY WITH MIXER AND DIVERTER ON PLATE (WITH SHOWER HEAD OR MOUTH DISPENSING)
FR - BATTERIE AVEC MÉLANGEUR ET DÉVIEUR SUR PLAQUE (AVEC CHALUMEAU OU BOUCHE DE DISTRIBUTION)
ES - BATERÍA CON MEZCLADOR Y DESVIADOR EN PLACA (CON DUCHA O BOCA DE DISPENSACIÓN)
RU - БАТАРЕЯ С МИКСЕРОМ И РАЗВОДИТЕЛЕМ НА ПЛАСТИНЕ (С ПОДАЧЕЙ ДУШЕВОЙ ГОЛОВКИ ИЛИ РТА)

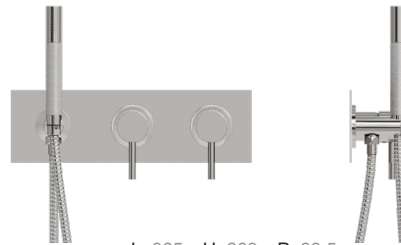

mm L: 365 x H: 263 x P: 88,5

ART. 42/FR

FREESTANDING PER LAVABO
EN - FREESTANDING FOR WASHBASINS
FR - FREESTANDING POUR LAVABO
ES - FREESTANDING PARA LAVABO
RU - ОТДЕЛЬНО УСТАНОВЛИВАЕТСЯ ДЛЯ УМЫВАЛЬНИКОВ

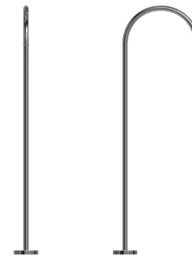

mm L: 119 x H: 1220 x P: 425

INTERASSE BOCCA EROGAZIONE: 350 mm Ø: 25 mm

ART. 3116/FR/DX

FREESTANDING PER VASCA CON DOCCETTA
EN - FREESTANDING FOR BATHTUB WITH SHOWER
FR - FREESTANDING POUR BAINOIRE AVEC DOUCHETTE
ES - FREESTANDING PARA BAÑERA CON DUCHA
RU - АВТОНОМНАЯ ВАННА С ДУШЕМ



mm L: 174 x H: 1050 x P: 265

INTERASSE BOCCA EROGAZIONE: 200 mm Ø: 25 mm



ART. 2900

STRUTTURA DOCCIA DA ESTERNO SENZA DOCCETTA
EN - OUTDOOR SHOWER STRUCTURE WITHOUT SHOWER
FR - STRUCTURE DE DOUCHE EXTÉRIEURE SANS DOUCHETTE
ES - ESTRUCTURA DE DUCHA EXTERIOR SIN DUCHA
RU - НАРУЖНАЯ ДУШЕВАЯ КОНСТРУКЦИЯ БЕЗ ДУША

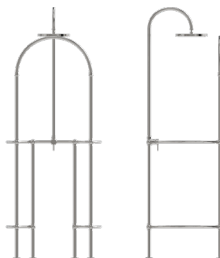

mm L: 905 x H: 2370 x P: 737



SERIE MINIMALE CUCINA



ART. 72

MONOFORO DA LAVELLO
EN - SINGLE SINK HOLE
FR - MONOTROU DE L'ÉVIER
ES - MONOFORO DE FREGADERO
RU - ОДНО ОТВЕРСТИЕ РАКОВИНЫ



mm L: 179 x H: 325 x P: 198

INTERASSE BOCCA EROGAZIONE: 165 mm Ø: 18 mm



ART. 84/C

MONOFORO DA LAVELLO
EN - SINGLE SINK HOLE
FR - MONOTROU DE L'ÉVIER
ES - MONOFORO DE FREGADERO
RU - ОДНО ОТВЕРСТИЕ РАКОВИНЫ

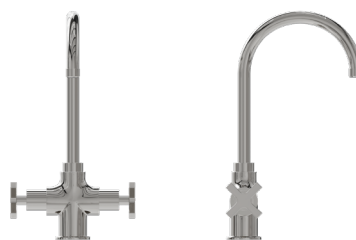

mm L: 179 x H: 327 x P: 196

INTERASSE BOCCA EROGAZIONE: 165 mm Ø: 18 mm



ART. 126/C

BATTERIA DA BORDO LAVELLO 5 FORI CON DOCCINO ESTRAIBILE
EN - 5-HOLE SINK EDGE BATTERY WITH REMOVABLE SHOWER
FR - BATTERIE DE BORD ÉVIER 5 TROUS AVEC DOUCHE AMOVIBLE
ES - BATERÍA DE BORDE FREGADERO 5 AGUJEROS CON DUCHA EXTRAÍBLE
RU - 5-HOLE SINK EDGE BATTERY С СЪЕМНЫМ ДУШЕМ



mm H: 250 x P: 204

INTERASSE BOCCA EROGAZIONE: 165 mm Ø: 20 mm



ART. 142/C

BATTERIA DA LAVELLO 3 FORI
EN - 3-HOLE SINK MIXER
FR - MIXEUR D'ÉVIER À 3 TROUS
ES - Grifo mezclador de fregadero de 3 orificios
RU - Трехотверстийный смеситель для мойки

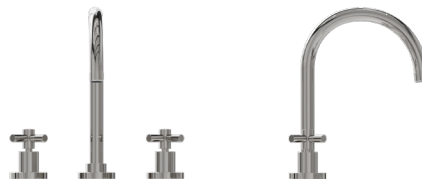

mm H: 250 x P: 204

INTERASSE BOCCA EROGAZIONE: 165 mm Ø: 20 mm



ART. 142/P/C

BATTERIA DA PARETE PER LAVELLO
EN - WALL BATTERY FOR SINK
FR - BATTERIE MURALE POUR ÉVIER
ES - BATERÍA DE PARED PARA FREGADERO
RU - НАСТЕННАЯ БАТАРЕЯ ДЛЯ РАКОВИНЫ



mm H: 84,5 x P: 261

INTERASSE BOCCA EROGAZIONE: 250 mm Ø: 20 mm

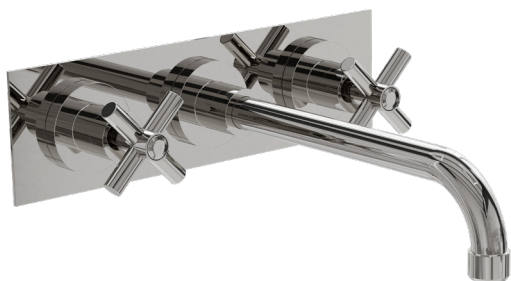

ART. 142/PL/C

BATTERIA DA PARETE PER LAVELLO CON PLACCA SAGOMATA
EN - SINK WALL BATTERY WITH SHAPED PLATE
FR - BATTERIE MURALE POUR ÉVIER AVEC PLAQUE PROFILÉE
ES - BATERÍA DE PARED PARA FREGADERO CON PLACA
RU - НАСТЕННАЯ БАТАРЕЯ РАКОВИНЫ С ПЛАСТИНОЙ ФОРМЫ



mm L: 280 x H: 97,3 x P: 263

INTERASSE BOCCA EROGAZIONE: 250 mm Ø: 20 mm



ART. 154

GRUPPO DA PARETE PER LAVELLO
EN - SINK WALL ASSEMBLY
FR - GROUPE MURAL POUR ÉVIER
ES - GRUPO DE PARED PARA FREGADERO
RU - СБОРКА СТЕНОК РАКОВИНЫ



mm L: 256 x H: 175 x P: 279

INTERASSE BOCCA EROGAZIONE: 200 mm Ø: 20 mm

ART. 154/R

GRUPPO DA PARETE PER LAVELLO CON BOCCA ROVESCIA
EN - SINK WALL ASSEMBLY WITH INVERTED MOUTH
FR - ENSEMBLE MURAL POUR ÉVIER À BOUCHE INVERSÉE
ES - GRUPO DE PARED PARA FREGADERO CON BOCA INVERTIDA
RU - СБОРКА СТЕНОК УМЫВАЛЬНИКА С ПЕРЕВЕРНУТЫМ РТОМ



mm L: 256 x H: 128 x P: 279

INTERASSE BOCCA EROGAZIONE: 200 mm Ø: 20 mm

ART. 2126

MISCELATORE PER LAVELLO CON LEVA E DOCCETTA ESTRAIBILE (CARTUCCIA DIAMETRO 40 mm)
EN - SINK MIXER WITH LEVER AND REMOVABLE SHOWER (CARTRIDGE DIAMETER 40 mm)
FR - MÉLANGEUR POUR ÉVIER AVEC LEVIER ET DOUCHETTE AMOVIBLE
(CARTOUCHE DIAMÈTRE 40 mm)
ES - MEZCLADOR PARA FREGADERO CON PALANCA Y DUCHA EXTRAÍBLE
(CARTUCHO DIÁMETRO 40 mm)
RU - Миксер для раковин с рычагом и съемным душем (диаметр картриджа 40 мм)



mm H: 294 x P: 224

INTERASSE BOCCA EROGAZIONE: 180 mm Ø: 25 mm

ART. 2142/C

MISCELATORE PER LAVELLO CON LEVA (CARTUCCIA DIAMETRO 40 mm)
EN - SINK MIXER WITH LEVER (CARTRIDGE DIAMETER 40 mm)
FR - MÉLANGEUR POUR ÉVIER AVEC LEVIER (CARTOUCHE DIAMÈTRE 40 mm)
ES - MEZCLADOR DE FREGADERO CON PALANCA (CARTUCHO DIÁMETRO 40 mm)
RU - МИКСЕР ДЛЯ РАКОВИН С РЫЧАГОМ (ДИАМЕТР КАРТРИДЖА 40 мм)



mm H: 259 x P: 198

INTERASSE BOCCA EROGAZIONE: 165 mm Ø: 18 mm

ART. 2142/P/C

MISCELATORE DA LAVELLO A PARETE CON LEVA
EN - WALL-MOUNTED SINK MIXER WITH LEVER
FR - MITIGEUR MURAL AVEC LEVIER
ES - MEZCLADOR DE FREGADERO CON PALANCA
RU - НАСТЕННАЯ РАКОВИНА С РЫЧАГОМ



mm H: 261 x P: 111

INTERASSE BOCCA EROGAZIONE: 200 mm Ø: 20 mm

ART. 2142/PL/C

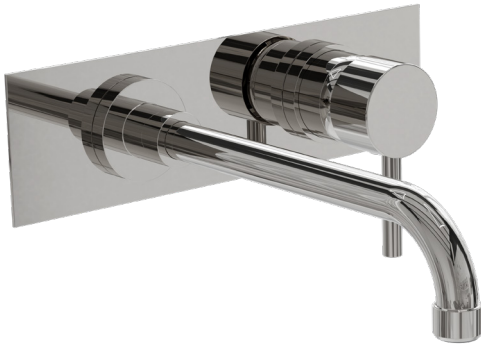

MISCELATORE DA LAVELLO A PARETE SU PLACCA CON LEVA
EN - WALL-MOUNTED SINK MIXER ON A LEVER
FR - MÉLANGEUR À LAVABO MURAL SUR PLAQUE AVEC LEVIER
ES - MEZCLADOR DE FREGADERO DE PARED EN PLACA CON PALANCA
RU - НАСТЕННЫЙ МИКСЕР ДЛЯ РАКОВИН НА РЫЧАГЕ



mm L: 280 x H: 123 x P: 263

INTERASSE BOCCA EROGAZIONE: 200 mm Ø: 20 mm

ART. 2154



GRUPPO DA PARETE PER LAVELLO CON MISCELATORE (CARTUCCIA DIAMETRO 40 mm)
EN - SINK WALL ASSEMBLY WITH MIXER (40 mm DIAMETER CARTRIDGE)
FR - GROUPE MURAL POUR LAVABO AVEC MÉLANGEUR (CARTOUCHE DIAMÈTRE 40 mm)
ES - GRUPO DE PARED PARA LAVABO CON MEZCLADOR (CARTUCHO DIÁMETRO 40 mm)
RU - РАКОВИНА С МИКСЕРОМ (КАРТРИДЖ ДИАМЕТРОМ 40 мм)



mm L: 254 x H: 237 x P: 300

INTERASSE BOCCA EROGAZIONE: 200 mm Ø: 20 mm

ART. 3072



MISCELATORE MONOFORO PER LEVELLO CON BOCCA A MANICO D'OMBRELLO (CARTUCCIA DIAMETRO 35 mm)
EN - SINGLE-HOLE MIXER FOR UMBRELLA-SLEEVE SINK (35 mm DIAMETER CARTRIDGE)
FR - MÉLANGEUR MONOPHONÉ POUR LE CHEVEU AVEC BOUCHE À MANCHE D'OMBRELLE
(CARTOUCHE DIAMÈTRE 35 mm)
ES - MEZCLADOR MONOAGUJERO PARA LEVELLO CON BOCA DE MANGO DE PARAGUAS
(CARTUCHO DE 35mm DE DIÁMETRO)
RU - ОДНОДУРНОЧНЫЙ МИКСЕР ДЛЯ РАКОВИНЫ-РУКАВА (КАРТРИДЖ ДИАМЕТРОМ 35 мм)



mm L: 104 x H: 328 x P: 195

INTERASSE BOCCA EROGAZIONE: 165 mm Ø: 18 mm

ART. 3074



MISCELATORE MONOFORO PER LAVELLO CON DOCCETTA ESTRAIBILE (CARTUCCIA DIAMETRO 35 mm)
EN - SINGLE-HOLE SINK MIXER WITH REMOVABLE SHOWER (35mm DIAMETER CARTRIDGE)
FR - MÉLANGEUR MONOPHORE POUR EVIER AVEC DOUCHETTE AMOVIBLE (CARTOUCHE DIAMÈTRE 35mm)
ES - MEZCLADOR MONOPHONEL PARA FREGADERO CON DUCHA EXTRAÍBLE (CARTUCHO DIÁMETRO 35mm)
RU - Одноотверстный миксер с раковиной и съемным душем (картридж диаметром 35 мм)



mm L: 104 x H: 370 x P: 221

INTERASSE BOCCA EROGAZIONE: 180 mm Ø: 25 mm

FINITURE



OTTONE
NATURALE
LUCIDO



OTTONE
OPACO



OTTONE
SPAZZOLATO



CROMO
LUCIDO



NIKEL
LUCIDO



NIKEL-NERO
LUCIDO



BRUNITO
NATURALE
CHIARO



CORTEN



PELTRO
INVECCHIATO



NIKEL
SPAZZOLATO



ORO INGLESE
LUCIDO



ORO 24K
LUCIDO

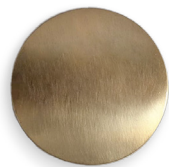

ORO FRANCESE
SPAZZOLATO



RAME
LUCIDO



RAME
SPAZZOLATO



RAME
INVECCHIATO

INDICE CODICI

- RUBINETTERIE / GRUPPI VASCA -

P - PAVIMENTO/PARETE

PL - PLACCA SU PARETE

C - CUCINA

B - BIDET

M - BOCCA MEDIA

F - BOCCA DI FUSIONE

FR - COLONNA/FREESTANDING

SA - SCARICO ALTO

SM - SCARICO MEDIO

ABB - SNODO ABBATTIBILE

R - BOCCA ROVESCIA

L - LEVA

- GRUPPI DOCCIA -

S - SOFFIONE DOCCIA

DX - DOCCETTA

- CARTUCCE -

Codice 2000 - CARTUCCIA DIAM. 40mm

Codice 3000 - CARTUCCIA DIAM. 35mm

LINEE GUIDA PER LA MISURAZIONE

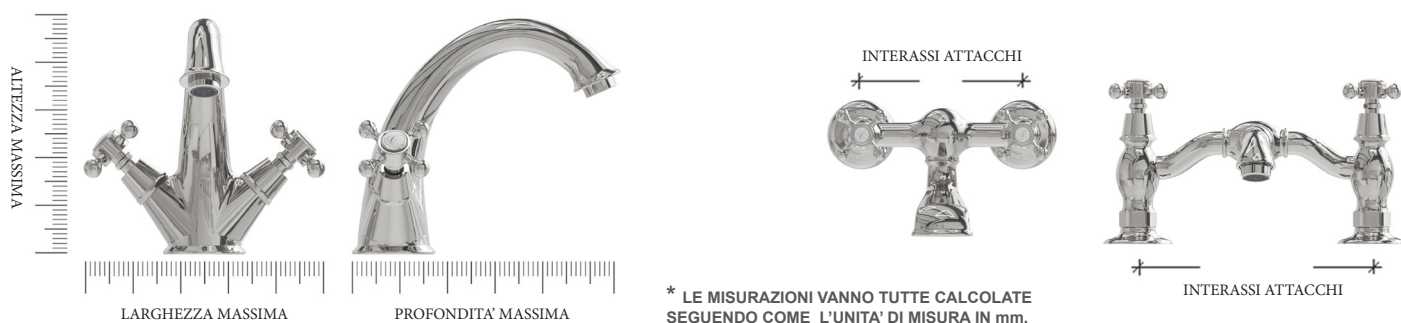

LINEE GUIDA PER LA PULIZIA CLEANING GUIDELINES

NON USARE LE SEGUENTI SOSTANZE SULLE RUBINETTERIE:

- Prodotti abrasivi
- Diluenti
- Sostanze a base acida
- Agenti chimici

TRATTARE LE RUBINETTERIE CON:

- un panno morbido e sapone neutro
- un panno morbido e 50% acqua +50% aceto bianco (in caso di calcare)

Si consiglia di asciugare le rubinetterie e inclinare i soffioni dopo ogni utilizzo.

DO NOT USE THE FOLLOWING SUBSTANCES ON FAUCETS:

- Abrasive products
- Diluents
- Acid-based substances
- Chemical agents

TREAT FAUCETS WITH:

- a soft cloth and neutral soap
- a soft cloth and 50% water +50% white vinegar (in case of limescale)

It is recommended to dry the taps and tilt the shower heads after each use.



CONDIZIONI GENERALI DI VENDITA

Con il conferimento dell'ordine il Cliente dichiara di aver preso attenta visione del presente regolamento e accetta incondizionatamente tutte le norme di seguito riportate da Rubinetti di Firenze Srl attraverso il proprio marchio commerciale Rubinetterie Fiorentine.

PREZZI

Fanno fede i prezzi e gli articoli con le caratteristiche riportate nella conferma d'ordine, che salvo diversi accordi, si intendono franco fabbrica (Via Antonio Vivaldi, 21 Calenzano Firenze); tali prezzi non comprendono Imballaggio, trasporto, assicurazione, dogana e IVA. Condizioni contrarie o diverse del cliente non vengono riconosciute, a meno che non siano state espressamente accettate da parte nostra. Ogni ordine potrà essere valido solo se confermato da entrambe le parti.

Ci riserviamo il diritto di modificare i prezzi di listino, laddove si presentino incrementi dei costi a causa di aumenti dei prezzi del materiale. Eventuali variazioni verranno tempestivamente comunicate.

L'ordine potrà essere annullato con comunicazione scritta pervenuta alla scrivente a mezzo e-mail entro l'invio della nostra conferma d'ordine.

PAGAMENTI

Il cliente è chiamato a effettuare i pagamenti conformemente a quanto disposto nella conferma d'ordine, ogni variazione che non sia stata preventivamente ed espressamente pattuita, verrà nostro malgrado respinta.

Il pagamento si considera effettuato solo nel momento in cui l'importo dovuto venga accreditato in maniera irrevocabile.

In caso di insoluto o ritardato pagamento interviene automaticamente il blocco ordini sino al saldo dello scaduto o alla formale accettazione di un piano di rientro con applicazione delle spese oltre agli interessi.

TERMINI DI CONSEGNA

I termini di consegna e le scadenze da noi indicati si intendono approssimativi, salvo il caso in cui siano stati concordati come vincolanti.

Il termine di consegna inizia a decorrere a partire dalla conferma d'ordine, ma non prima che il cliente abbia consegnato tutti i documenti ed i dati relativi a dettagli tecnici, approvazioni, autorizzazioni ed eventuali acconti concordati.

Il termine di consegna si prolunga congruamente in caso di vertenze sindacali nonché al verificarsi di impedimenti imprevisti che non rientrano sotto il nostro controllo. Se il cliente non ritira immediatamente la merce dichiarata pronta per la spedizione, passate due settimane da tale comunicazione gli vengono addebitate le spese di magazzino. In caso di deposito presso il nostro stabilimento tali spese ammontano a min. 0,5% dell'importo della fattura per ogni settimana.

RECLAMI

Non saranno ritenuti validi i reclami successivi alla consegna, se non segnalati con riserva scritta sui documenti di trasporto entro e non oltre il secondo giorno lavorativo successivo al ricevimento merci. Rubinetti di Firenze SRL si riserva il diritto di adempiere al contratto in via posticipata entro un termine adeguato, scegliendo se rimuovere i difetti o inviare una nuova fornitura di merce non difettosa.

Il diritto di reclamo per merce difettosa cade in prescrizione a un anno dalla consegna della merce.

GARANZIA

I prodotti dell'azienda Rubinetti di Firenze Srl sono rigorosamente provati e collaudati prima di essere posti in vendita, sono esenti da difetti di fabbricazione e sono garantiti per un periodo di anni 5 per la finitura cromo e anni 2 per tutte le altre finiture.

La garanzia decade ad insindacabile giudizio dei nostri tecnici al verificarsi di:

- installazioni, riparazioni o manutenzioni effettuate in modo non idoneo, non corretto o senza previa autorizzazione dell'azienda.
- cattivo utilizzo o uso improprio delle parti fornite.
- deterioramento delle superfici di finitura a seguito utilizzo di prodotti per la pulizia non idonei (contenenti agenti corrosivi, abrasivi, etc).

Firenze

Rubinetti di Firenze Srl
03/04/2026

Contatti:
Rubinetterie Fiorentine
Via Antonio Vivaldi 21 - 50041 - Calenzano (FI) - Italy

Tel. (+39) 055 88 27 486
(+39) 055 88 61 329
Fax. (+39) 055 88 77 584
info@rubfio.it
www.rubfio.it

